

ADJUSTABLE PRECISION SHUNT REGULATORS**AZ431-B****General Description**

The AZ431-B is a three-terminal adjustable shunt regulator with guaranteed thermal stability over a full operation range. It features sharp turn-on characteristics, low temperature coefficient and low output impedance, which make it ideal substitute for Zener diode in applications such as switching power supply, charger and other adjustable regulators.

The output voltage of AZ431-B can be set to any value between V_{REF} (2.5V) and the corresponding maximum cathode voltage.

The AZ431-B precision reference is offered in two voltage tolerance: 0.4% and 0.8%.

This IC is available in 4 packages: TO-92 (bulk or ammo packing), SOT-23, SOT-23-5 and SOT-89.

Features

- Programmable Precise Output Voltage from 2.5V to 18V
- High Stability under Capacitive Load
- Low Temperature Deviation: 4.5mV Typical
- Low Equivalent Full-range Temperature Coefficient with 20PPM/°C Typical
- Sink Current Capacity from 1mA to 100mA
- Low Output Noise
- Wide Operating Range of -40 to 125°C

Applications

- Charger
- Voltage Adapter
- Switching Power Supply
- Graphic Card
- Precision Voltage Reference

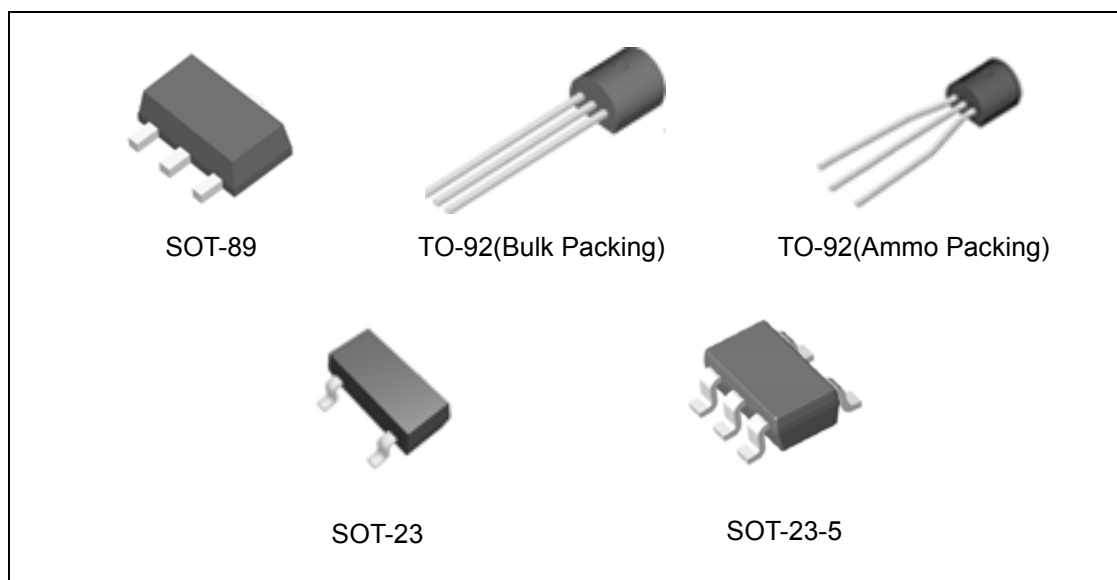

Figure 1. Package Types of AZ431-B

ADJUSTABLE PRECISION SHUNT REGULATORS

AZ431-B

Pin Configuration

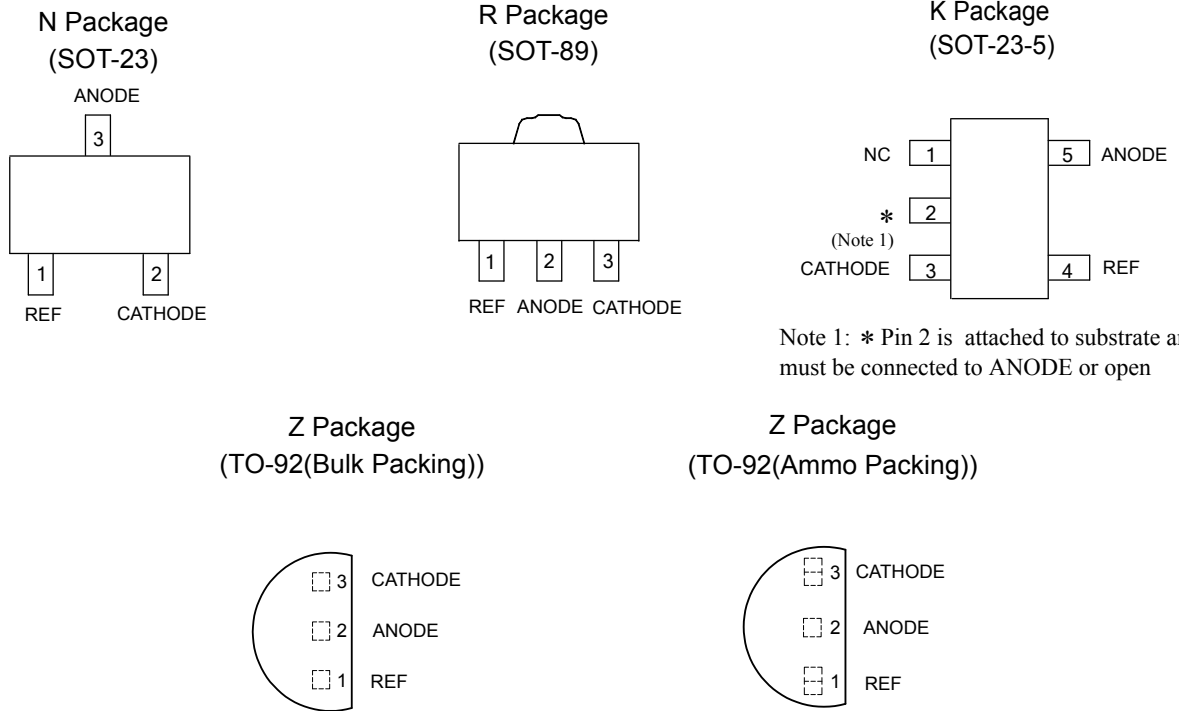

Figure 2. Pin Configuration of AZ431-B (Top View)

Functional Block Diagram

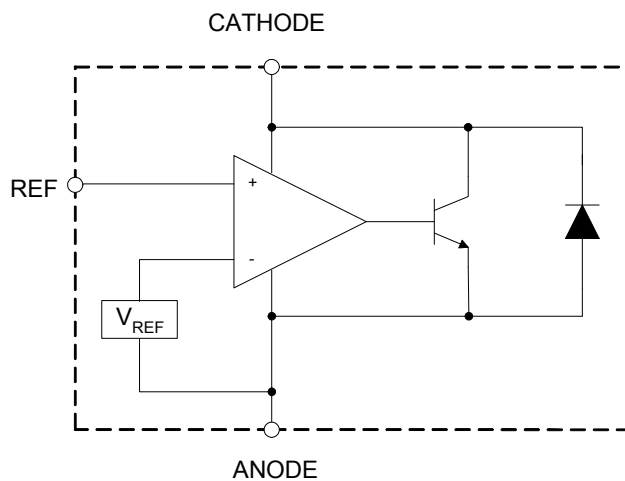
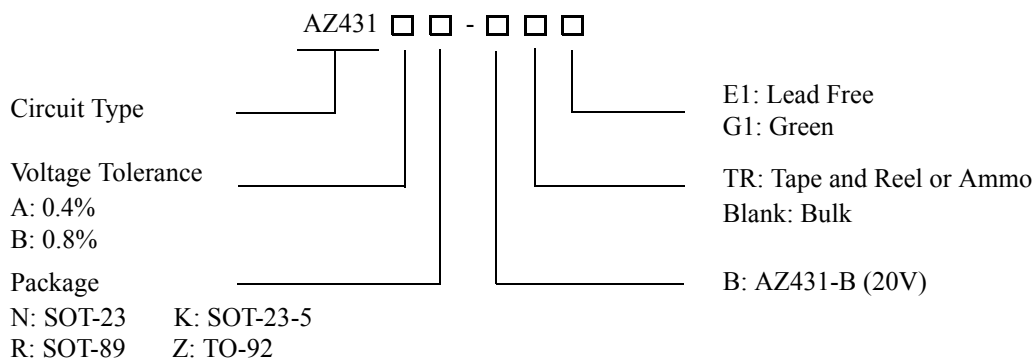

Figure 3. Functional Block Diagram of AZ431-B



ADJUSTABLE PRECISION SHUNT REGULATORS **AZ431-B**

Ordering Information



Package	Temperature Range	Voltage Tolerance	Part Number		Marking ID		Packing Type
			Lead Free	Green	Lead Free	Green	
SOT-23	-40 to 125°C	0.4%	AZ431AN-BTRE1	AZ431AN-BTRG1	EA4	GA4	Tape & Reel
		0.8%	AZ431BN-BTRE1	AZ431BN-BTRG1	EA5	GA5	Tape & Reel
SOT-23-5	-40 to 125°C	0.4%	AZ431AK-BTRE1	AZ431AK-BTRG1	E4A	G4A	Tape & Reel
		0.8%	AZ431BK-BTRE1	AZ431BK-BTRG1	E4B	G4B	Tape & Reel
TO-92	-40 to 125°C	0.4%	AZ431AZ-BE1	AZ431AZ-BG1	AZ431AZ-BE1	AZ431AZ-BG1	Bulk
		0.4%	AZ431AZ-BTRE1	AZ431AZ-BTRG1	AZ431AZ-BE1	AZ431AZ-BG1	Ammo
		0.8%	AZ431BZ-BE1	AZ431BZ-BG1	AZ431BZ-BE1	AZ431BZ-BG1	Bulk
		0.8%	AZ431BZ-BTRE1	AZ431BZ-BTRG1	AZ431BZ-BE1	AZ431BZ-BG1	Ammo
SOT-89	-40 to 125°C	0.4%	AZ431AR-BTRE1	AZ431AR-BTRG1	E43C	G43C	Tape & Reel
		0.8%	AZ431BR-BTRE1	AZ431BR-BTRG1	E43D	G43D	Tape & Reel

BCD Semiconductor's Pb-free products, as designated with "E1" suffix in the part number, are RoHS compliant. Products with "G1" suffix are available in green packages.

**ADJUSTABLE PRECISION SHUNT REGULATORS****AZ431-B****Absolute Maximum Ratings (Note 2)**

Parameter	Symbol	Value	Unit
Cathode Voltage	V_{KA}	20	V
Cathode Current Range (Continuous)	I_{KA}	-100 to 150	mA
Reference Input Current Range	I_{REF}	10	mA
Power Dissipation	P_D	Z, R Package: 770	mW
		N, K Package: 370	
Junction Temperature	T_J	150	°C
Storage Temperature Range	T_{STG}	-65 to 150	°C
ESD (Human Body Model)	ESD	2000	V

Note 2: Stresses greater than those listed under "Absolute Maximum Ratings" may cause permanent damage to the device. These are stress ratings only, and functional operation of the device at these or any other conditions beyond those indicated under "Recommended Operating Conditions" is not implied. Exposure to "Absolute Maximum Ratings" for extended periods may affect device reliability.

Recommended Operating Conditions

Parameter	Symbol	Min	Max	Unit
Cathode Voltage	V_{KA}	V_{REF}	18	V
Cathode Current	I_{KA}	1.0	100	mA
Operating Ambient Temperature Range	T_A	-40	125	°C



ADJUSTABLE PRECISION SHUNT REGULATORS

AZ431-B

Electrical Characteristics

Operating Conditions: $T_A=25^{\circ}\text{C}$, unless otherwise specified.

Parameter	Test Circuit	Symbol	Conditions	Min	Typ	Max	Unit	
Reference Voltage	0.4%	4	V_{REF}	$V_{\text{KA}}=V_{\text{REF}}, I_{\text{KA}}=10\text{mA}$	2.490	2.500	2.510	V
	0.8%				2.480	2.500	2.520	
Deviation of Reference Voltage Over Full Temperature Range	4	ΔV_{REF}	$V_{\text{KA}}=V_{\text{REF}}$ $I_{\text{KA}}=10\text{mA}$	0 to 70°C	4.5	8	mV	
				-40 to 85°C	4.5	10		
				-40 to 125°C	4.5	16		
Ratio of Change in Reference Voltage to the Change in Cathode Voltage	5	$\frac{\Delta V_{\text{REF}}}{\Delta V_{\text{KA}}}$	$I_{\text{KA}}=10\text{mA}$	$\Delta V_{\text{KA}}=10\text{V to }V_{\text{REF}}$	-1.0	-2.7	mV/V	
				$\Delta V_{\text{KA}}=18\text{V to }10\text{V}$	-0.5	-2.0		
Reference Current	5	I_{REF}	$I_{\text{KA}}=10\text{mA}, R1=10\text{K}\Omega, R2=\infty$		0.7	4	μA	
Deviation of Reference Current Over Full Temperature Range	5	ΔI_{REF}	$I_{\text{KA}}=10\text{mA}, R1=10\text{K}\Omega, R2=\infty$ $T_A=-40\text{ to }125^{\circ}\text{C}$		0.4	1.2	μA	
Minimum Cathode Current for Regulation	4	$I_{\text{KA}}(\text{Min})$	$V_{\text{KA}}=V_{\text{REF}}$		0.4	1.0	mA	
Off-state Cathode Current	6	$I_{\text{KA}}(\text{Off})$	$V_{\text{KA}}=18\text{V}, V_{\text{REF}}=0$		0.05	1.0	μA	
Dynamic Impedance	4	Z_{KA}	$V_{\text{KA}}=V_{\text{REF}}, I_{\text{KA}}=1\text{ to }100\text{mA}$ $f \leq 1.0\text{KHz}$		0.2	0.5	Ω	
Thermal Resistance		θ_{JC}	SOT-23		177.65		$^{\circ}\text{C/W}$	
			SOT-23-5		177.65			
			TO-92		107.04			
			SOT-89		30.30			

Electrical Characteristics (Continued)



Figure 4. Test Circuit 4 for $V_{KA} = V_{REF}$

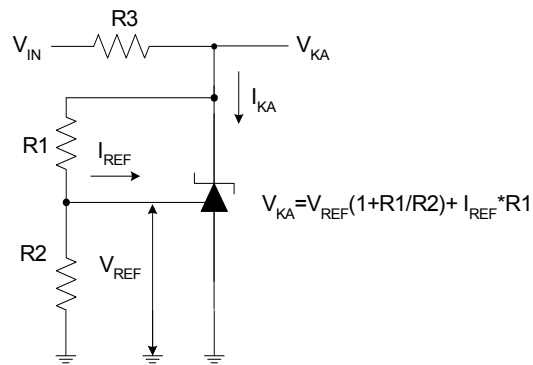

Figure 5. Test Circuit 5 for $V_{KA} > V_{REF}$

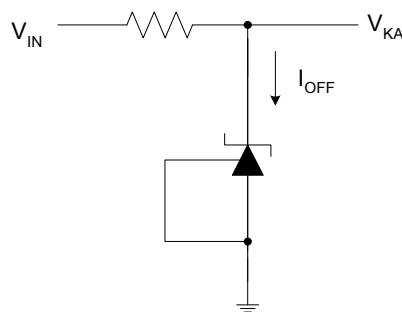

Figure 6. Test Circuit 6 for I_{OFF}



ADJUSTABLE PRECISION SHUNT REGULATORS

AZ431-B

Typical Performance Characteristics



Figure 7. Reference Voltage vs. Ambient Temperature



Figure 8. Reference Current vs. Ambient Temperature

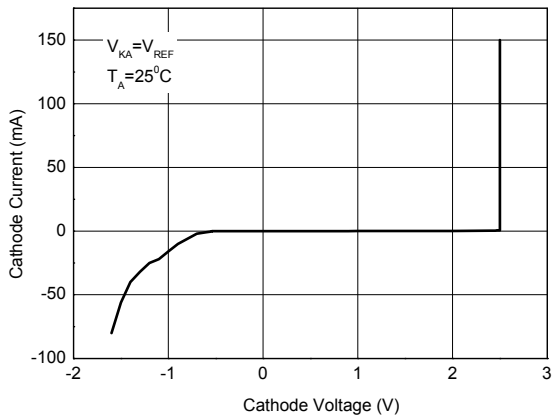

Figure 9. Cathode Current vs. Cathode Voltage

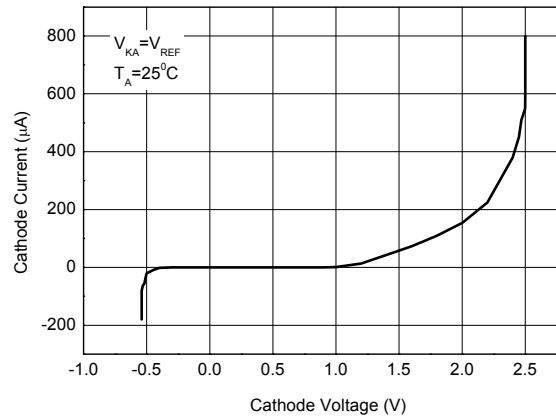

Figure 10. Cathode Current vs. Cathode Voltage



ADJUSTABLE PRECISION SHUNT REGULATORS

AZ431-B

Typical Performance Characteristics (Continued)

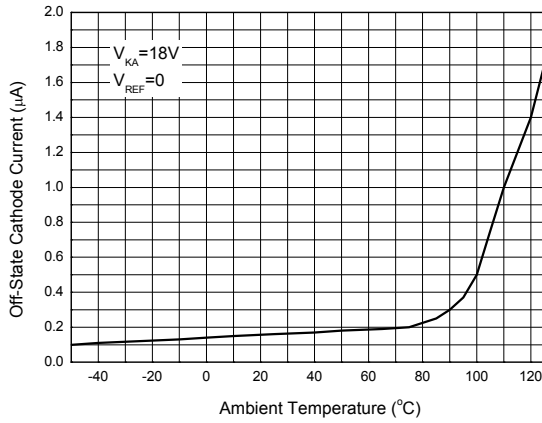

Figure 11. Off-State Cathode Current vs. Ambient Temperature

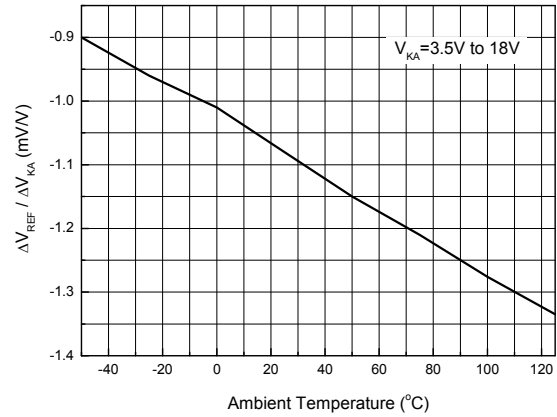

Figure 12. Ratio of Delta Reference Voltage to the Ratio of Delta Cathode Voltage

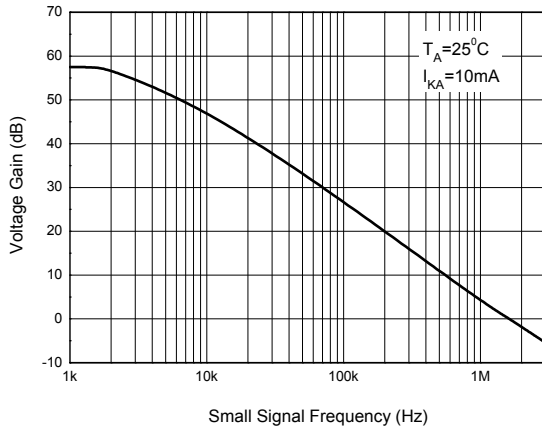
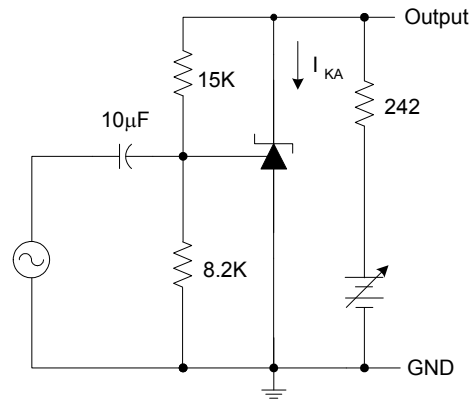

Figure 13. Small Signal Voltage Gain vs. Frequency



ADJUSTABLE PRECISION SHUNT REGULATORS

AZ431-B

Typical Performance Characteristics (Continued)

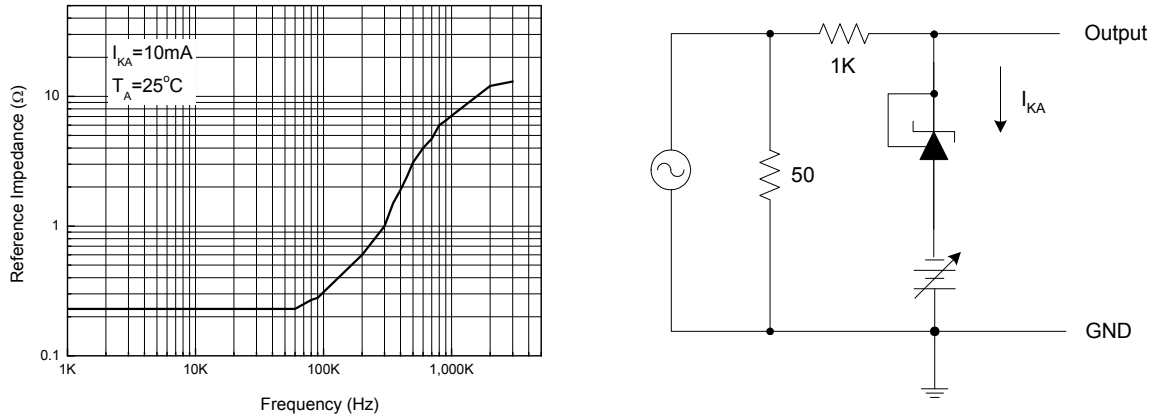

Figure 14. Reference Impedance vs. Frequency

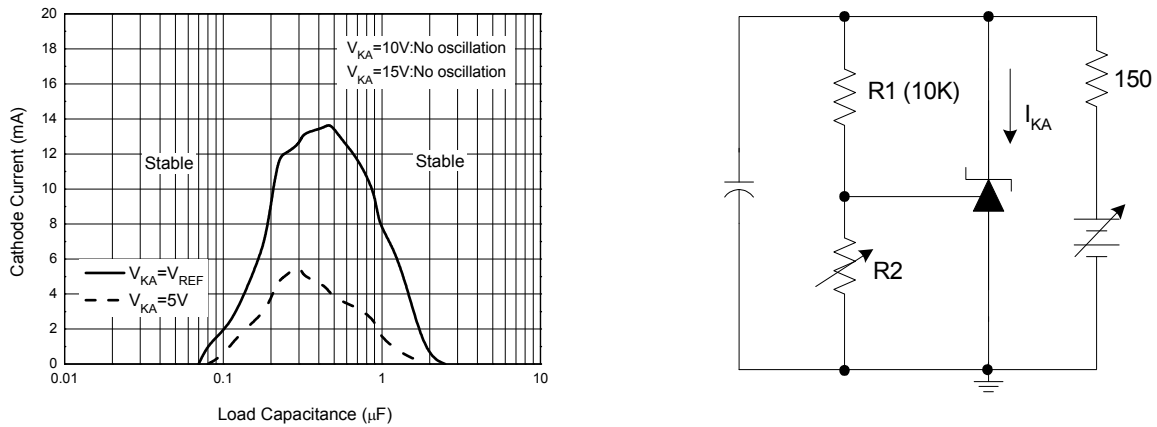

Figure 15. Stability Boundary Conditions vs. Load Capacitance

Typical Performance Characteristics (Continued)

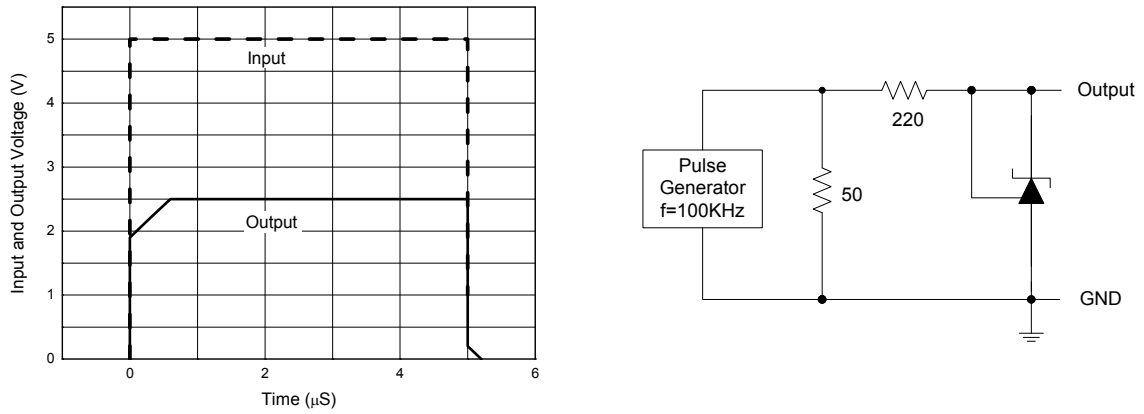

Figure 16. Pulse Response of Input and Output Voltage

Typical Application

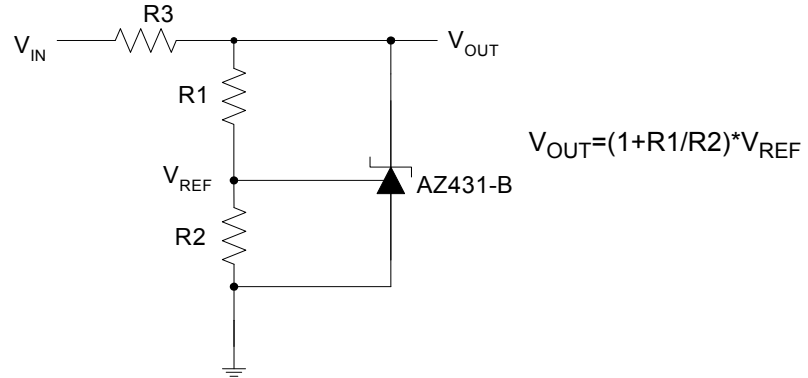

Figure 17. Shunt Regulator

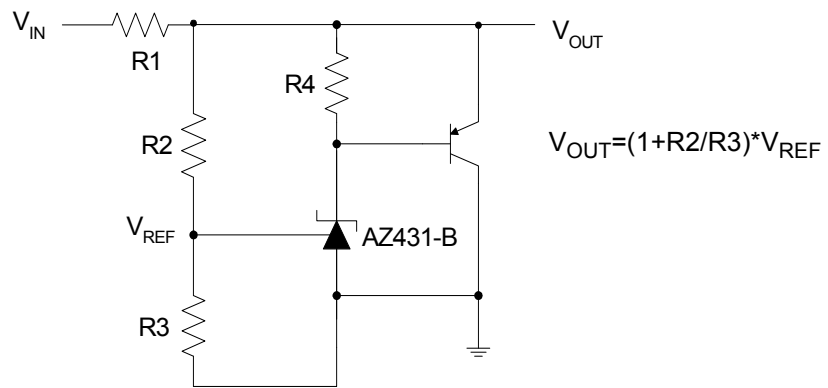

Figure 18. High Current Shunt Regulator

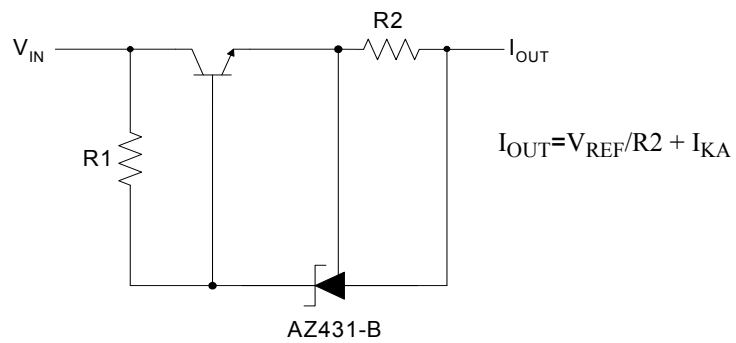

Figure 19. Current Source or Current Limit

Typical Application (Continued)

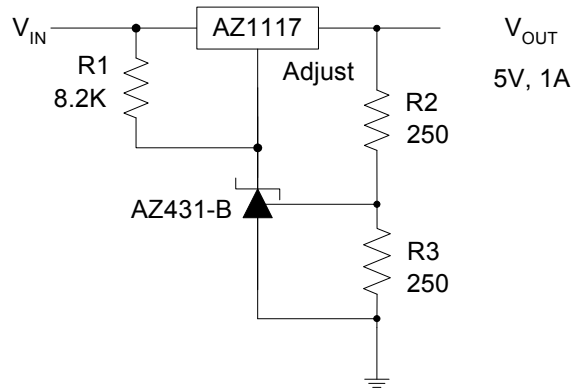

Figure 20. Precision 5V 1A Regulator

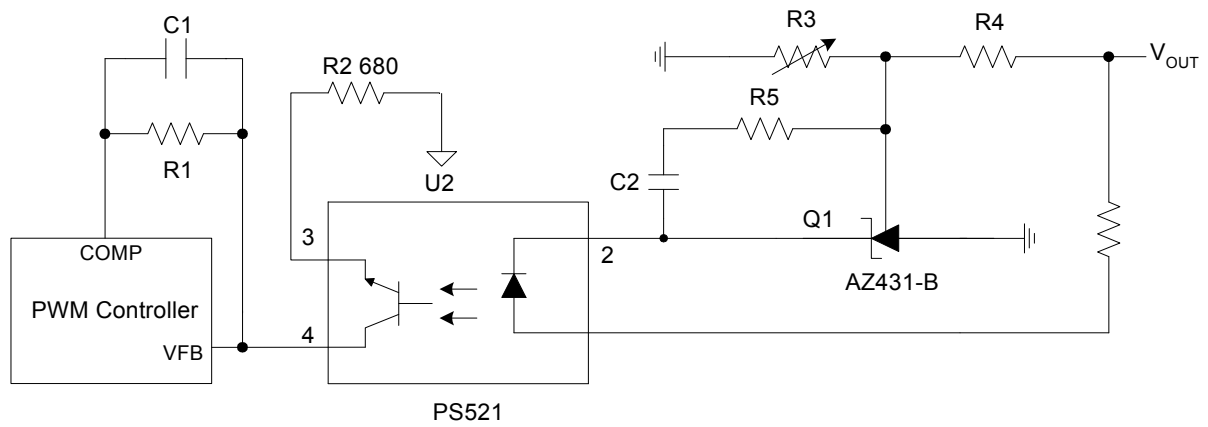

Figure 21. PWM Converter with Reference



ADJUSTABLE PRECISION SHUNT REGULATORS

AZ431-B

Mechanical Dimensions

TO-92(Bulk Packing)

Unit: mm(inch)

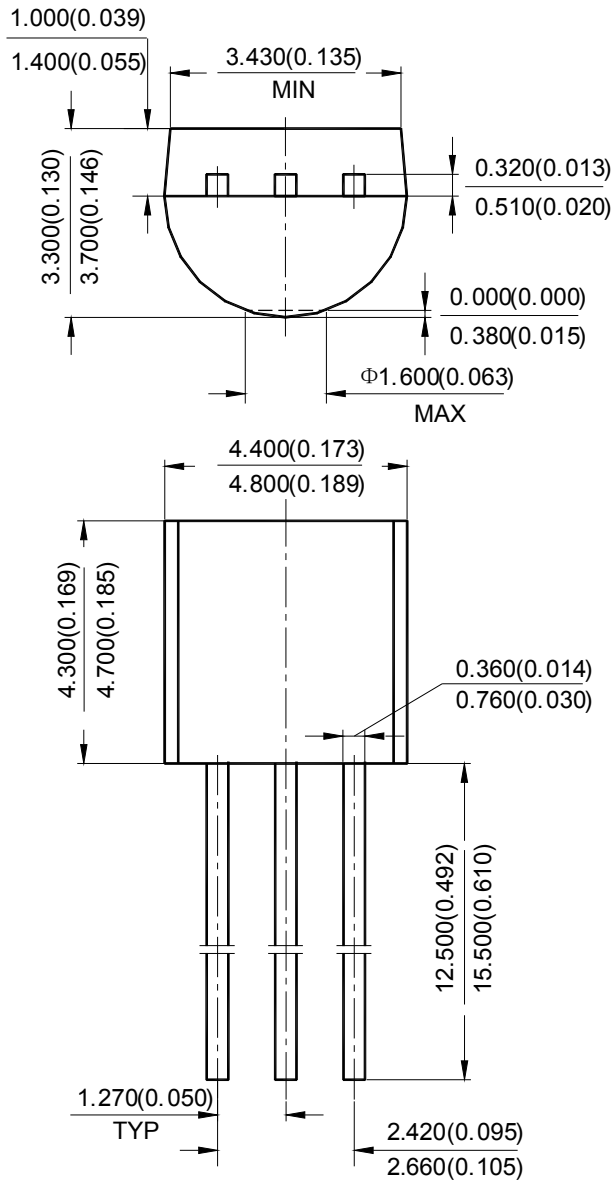



ADJUSTABLE PRECISION SHUNT REGULATORS

AZ431-B

Mechanical Dimensions (Continued)

TO-92(Ammo Packing)

Unit: mm(inch)





ADJUSTABLE PRECISION SHUNT REGULATORS

AZ431-B

Mechanical Dimensions (Continued)

SOT-23

Unit: mm(inch)

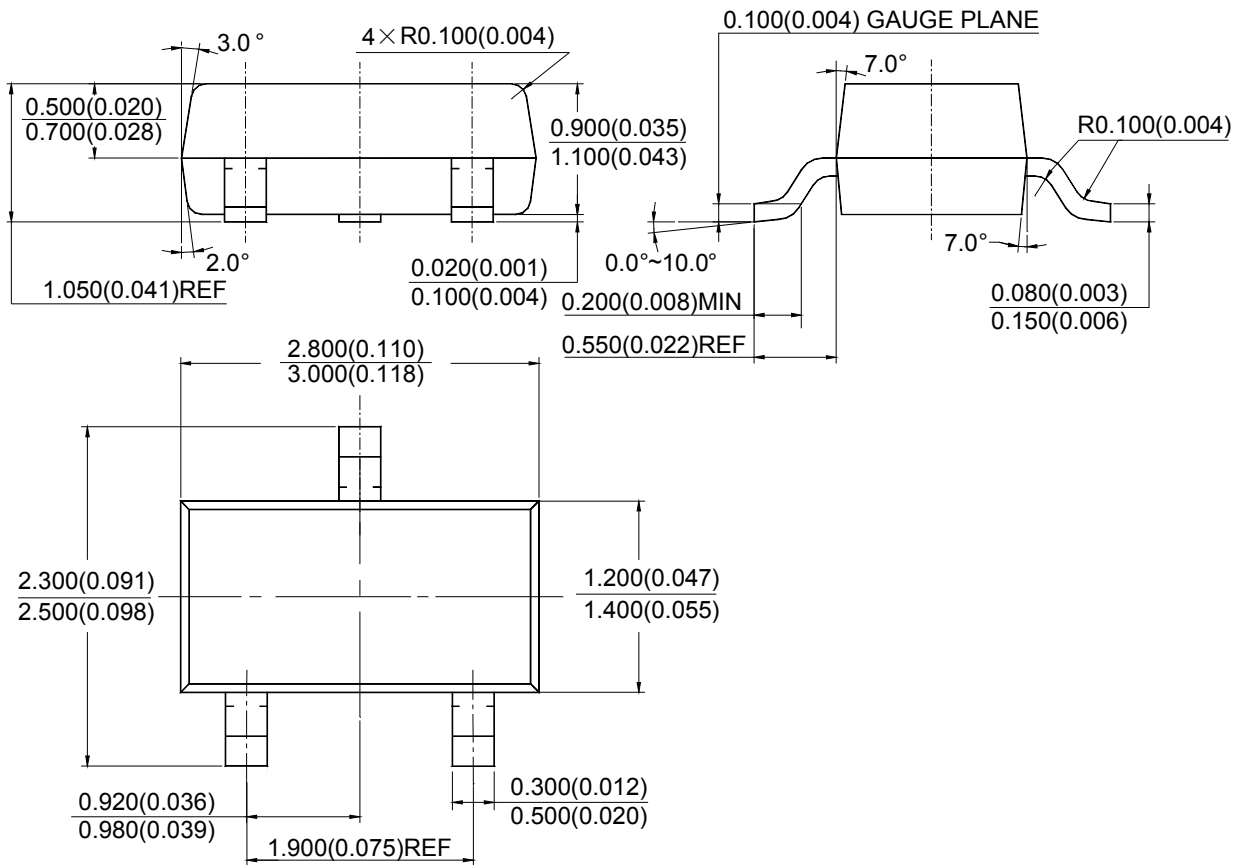



ADJUSTABLE PRECISION SHUNT REGULATORS

AZ431-B

Mechanical Dimensions (Continued)

SOT-23-5

Unit: mm(inch)

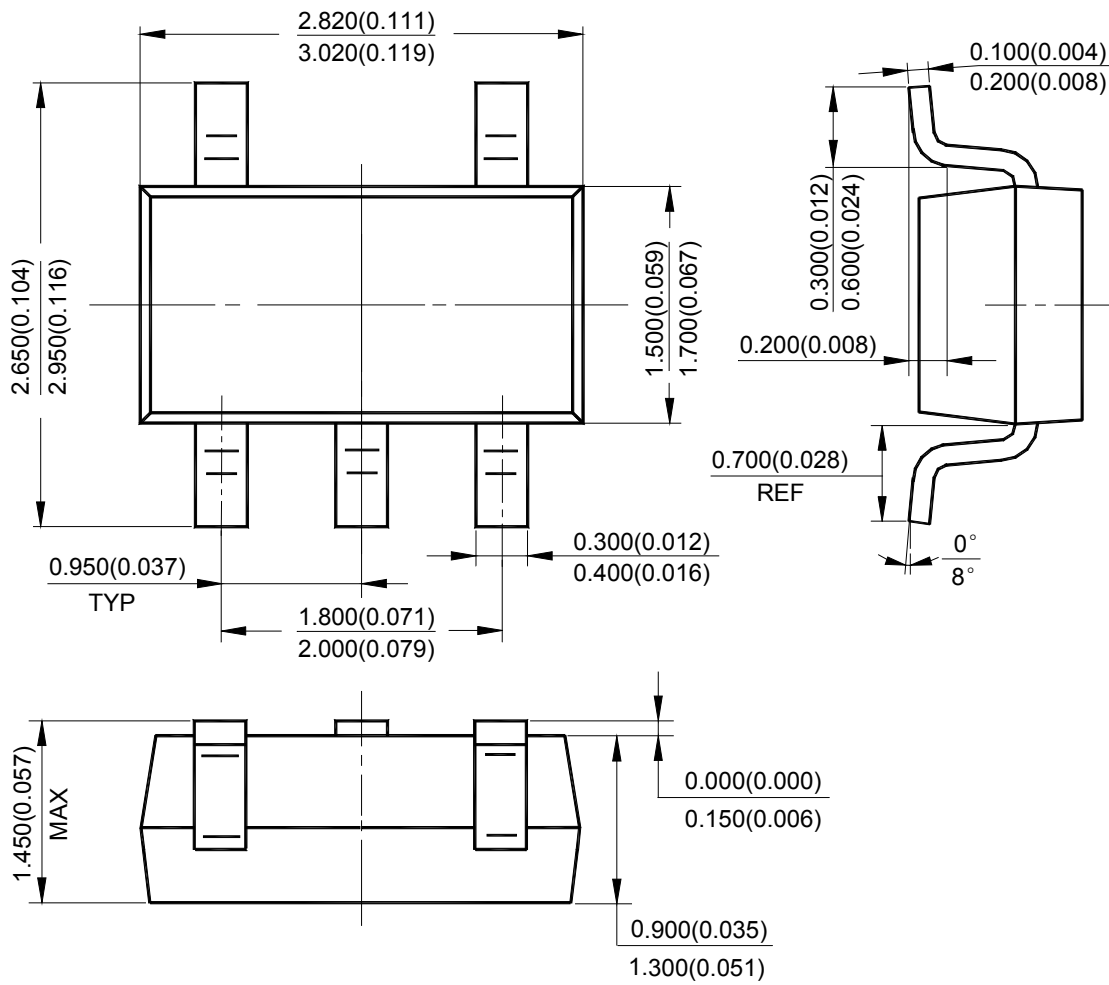



ADJUSTABLE PRECISION SHUNT REGULATORS

AZ431-B

Mechanical Dimensions (Continued)

SOT-89

Unit: mm(inch)

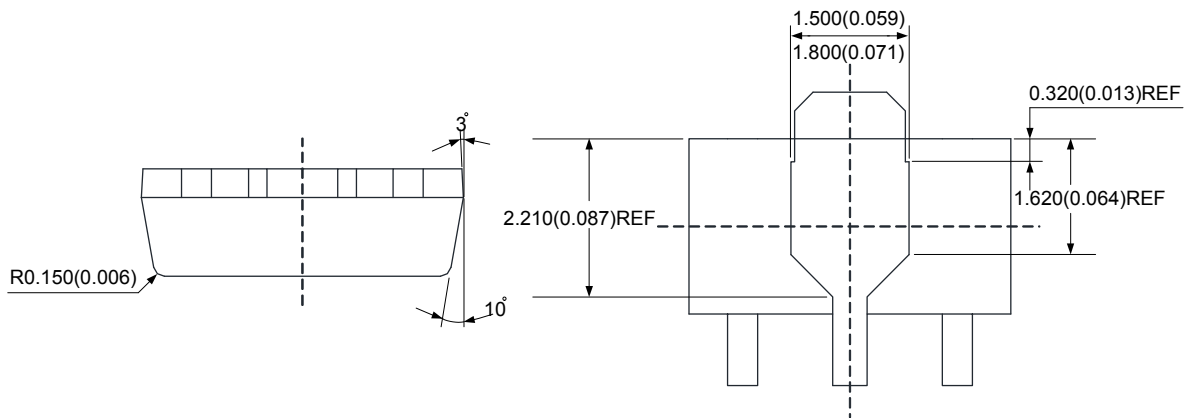
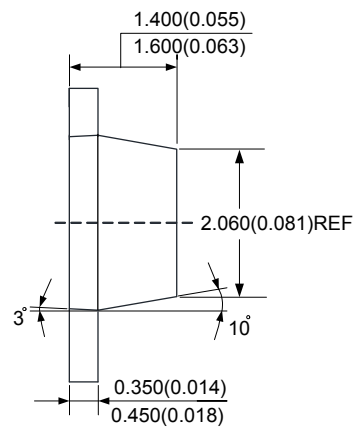
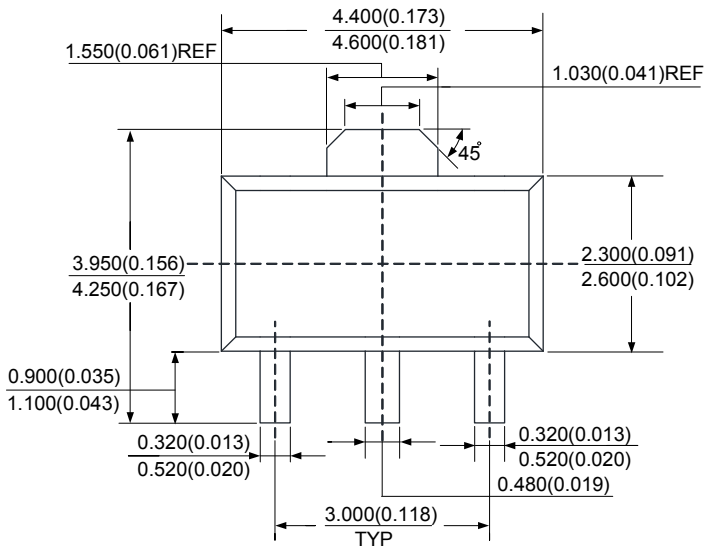



BCD Semiconductor Manufacturing Limited

<http://www.bcdsemi.com>

IMPORTANT NOTICE

BCD Semiconductor Manufacturing Limited reserves the right to make changes without further notice to any products or specifications herein. BCD Semiconductor Manufacturing Limited does not assume any responsibility for use of any its products for any particular purpose, nor does BCD Semiconductor Manufacturing Limited assume any liability arising out of the application or use of any its products or circuits. BCD Semiconductor Manufacturing Limited does not convey any license under its patent rights or other rights nor the rights of others.

MAIN SITE

- Headquarters

BCD Semiconductor Manufacturing Limited

No. 1600, Zi Xing Road, Shanghai Zizhu Science-based Industrial Park, 200241, China
Tel: +86-21-24162266, Fax: +86-21-24162277

- Wafer Fab

Shanghai SIM-BCD Semiconductor Manufacturing Co., Ltd.

800 Yi Shan Road, Shanghai 200233, China
Tel: +86-21-6485 1491, Fax: +86-21-5450 0008

REGIONAL SALES OFFICE

Shenzhen Office

Shanghai SIM-BCD Semiconductor Manufacturing Co., Ltd., Shenzhen Office

Unit A Room 1203, Skyworth Bldg., Gaoxin Ave. 1.S., Nanshan District, Shenzhen, China
Tel: +86-755-8826 7951
Fax: +86-755-8826 7865

Taiwan Office

BCD Semiconductor (Taiwan) Company Limited

4F, 298-1, Rui Guang Road, Nei-Hu District, Taipei, Taiwan
Tel: +886-2-2656 2808
Fax: +886-2-2656 2806

USA Office

BCD Semiconductor Corp.

30920 Huntwood Ave. Hayward, CA 94544, USA
Tel : +1-510-324-2988
Fax: +1-510-324-2788